



RAZER RAIJU TOURNAMENT EDITION

MASTER GUIDE

The **Razer Raiju Tournament Edition** is the first Bluetooth and wired controller to have a mobile configuration app, enabling control from remapping multi-function buttons to adjusting sensitivity clutch options. Mecha-Tactile Action Buttons provide a soft cushioned touch with crisp tactile feedback. The Raiju Tournament Edition also delivers total control with 4 remappable multi-function buttons and Hair Trigger Mode for quick-firing action. Switch between 3 connectivity modes: PS4, USB and PC without manual re-pairing for optimal efficiency.

CONTENTS

1. PACKAGE CONTENTS / SYSTEM REQUIREMENTS.....	3
2. REGISTRATION / TECHNICAL SUPPORT.....	4
3. TECHNICAL SPECIFICATIONS.....	5
4. DEVICE LAYOUT.....	6
5. SETTING UP YOUR RAZER RAIJU TOURNAMENT EDITION.....	8
6. USING YOUR RAZER RAIJU TOURNAMENT EDITION.....	16
7. USING THE RAZER RAIJU MOBILE APP.....	18
8. SAFETY AND MAINTENANCE	26
9. LEGALESE	27

1. PACKAGE CONTENTS / SYSTEM REQUIREMENTS

PACKAGE CONTENTS

- Razer Raiju Tournament Edition gaming controller for PS4®
- USB to Micro-USB cable
- Important Product Information Guide

SYSTEM REQUIREMENTS

PRODUCT REQUIREMENTS

- PlayStation®4 / PC
- Mobile device (iOS or Android)
- A free USB port or Bluetooth connectivity

MOBILE APP REQUIREMENTS

- iOS 9.0 and Android 6.0 (or higher)
- Internet connection
- 85 MB of free storage space

2. REGISTRATION / TECHNICAL SUPPORT

REGISTRATION

Register your product online at razerid.razer.com/warranty to get real-time information on your product's warranty status.

If you haven't registered for a Razer ID yet, register now at razerid.razer.com to get a wide range of Razer benefits.

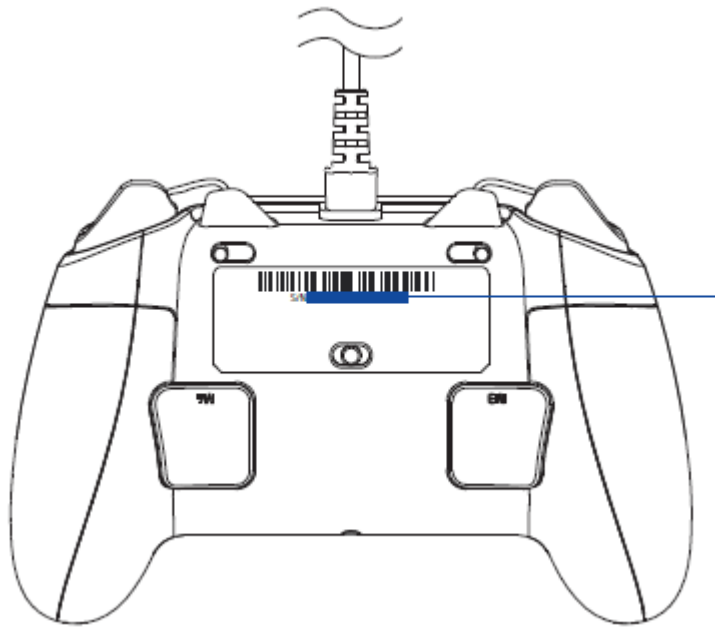

Your product's serial number can be found here.

TECHNICAL SUPPORT

- 1 year limited manufacturer's warranty.
- Free online technical support at support.razer.com.

3. TECHNICAL SPECIFICATIONS

TECHNICAL SPECIFICATIONS

- USB/Bluetooth Connectivity
- 4 multi-function buttons
- Mecha-Tactile triangle, circle, X, square action buttons
- Trigger stops for quick-firing action
- 3.5 mm audio port for stereo audio output and microphone input (USB Mode only)
- Detachable 2 m / 6.5 ft lightweight braided fiber cable with Micro-USB connector

APPROXIMATE SIZE & WEIGHT

- Length: 104 mm / 4.1 in
- Width: 159.4 mm / 6.28 in
- Height: 65.6 mm / 2.6 in
- Weight: 322 g / 0.71 lbs

4. DEVICE LAYOUT

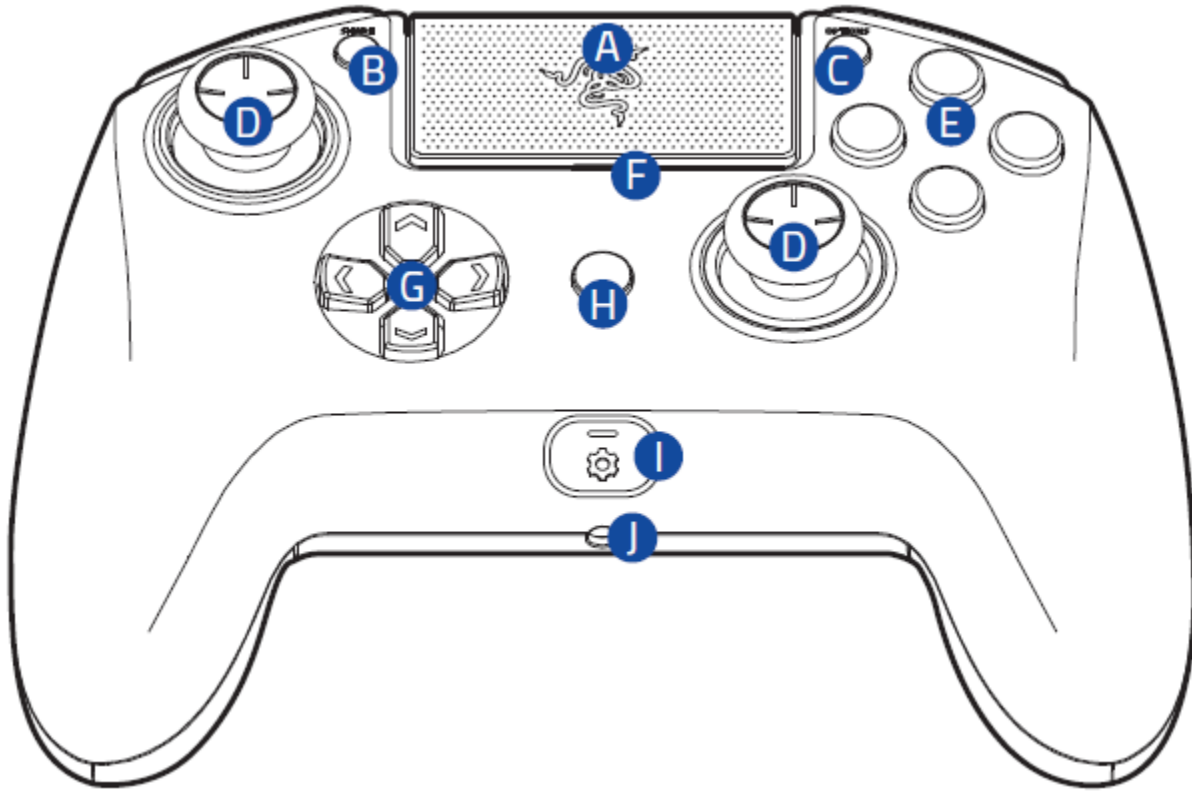

- A. Touchpad (Touchpad button)
- B. SHARE button
- C. OPTIONS button
- D. Analog sticks (L3/R3 buttons)
- E. Action buttons
- F. Status indicator
- G. Directional pad
- H. PS button
- I. Configure button
- J. Stereo headset jack*

**Audio function only available in USB mode*

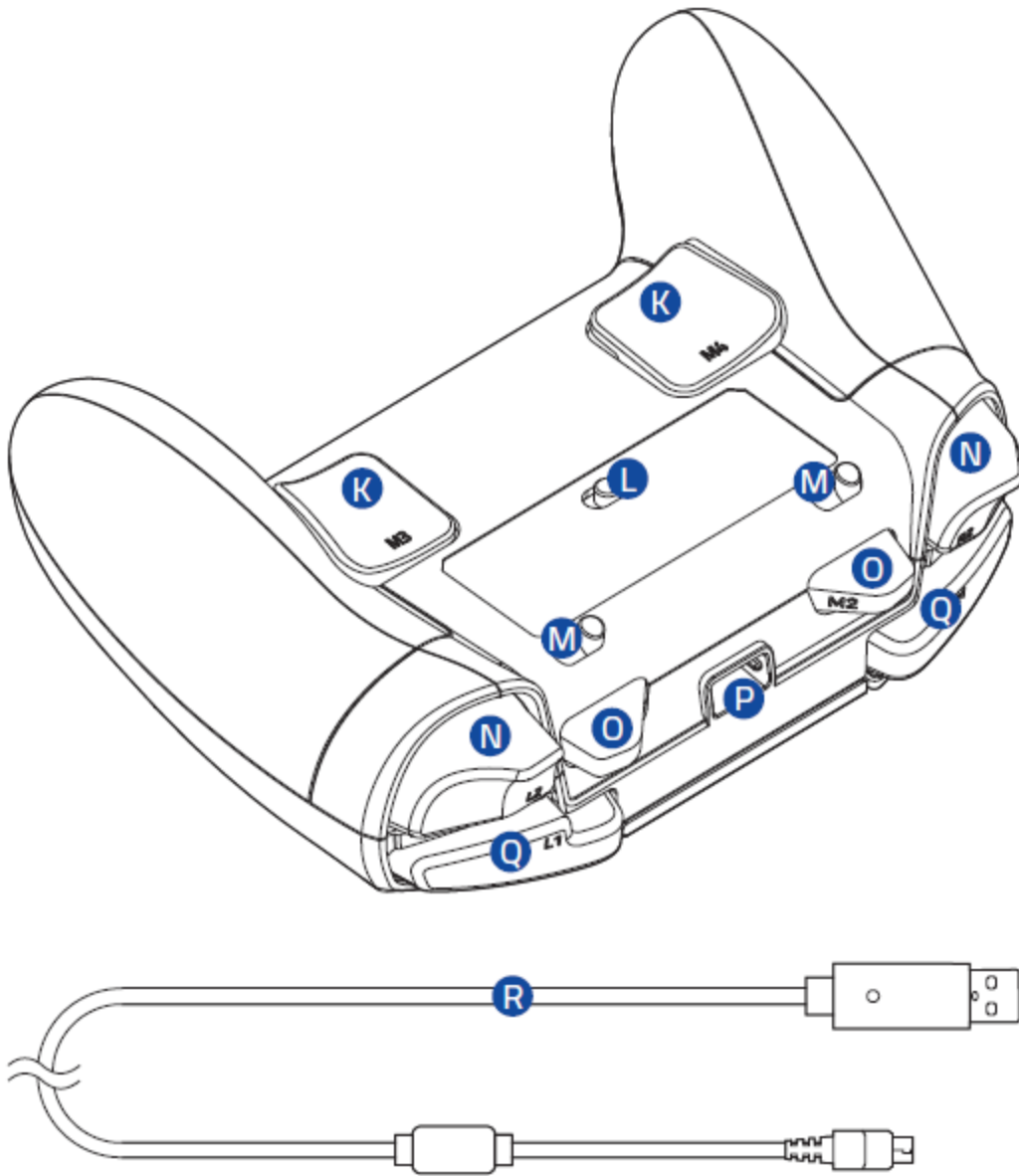

- K.** Multi-Function Triggers (M3/M4)
- L.** Mode switch
- M.** Trigger stop switches
- N.** Triggers (LT/RT)
- O.** Multi-Function Bumpers (M1/M2)
- P.** Micro-USB port
- Q.** Bumpers (LB/RB)
- R.** USB to Micro-USB cable

5. SETTING UP YOUR RAZER RAIJU TOURNAMENT EDITION

CHARGING YOUR RAZER RAIJU TOURNAMENT EDITION

For first time activation, please plug your controller to a powered USB port or use wired mode. It takes approximately 4 hours to fully charge your Razer Raiju Tournament Edition.

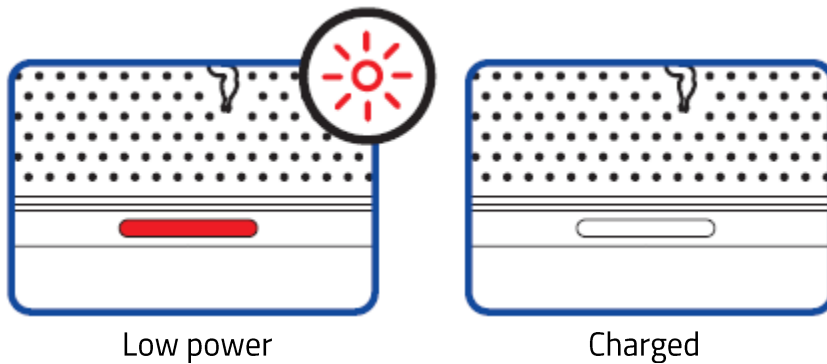

CONNECTING TO YOUR PLAYSTATION®4 CONSOLE

WIRED MODE

1. Set the Mode switch to **USB**.



2. Plug the micro-USB connector to your Razer Raiju Tournament Edition.



3. Plug the USB connector of your Razer Raiju Tournament Edition to your PlayStation®4 console.

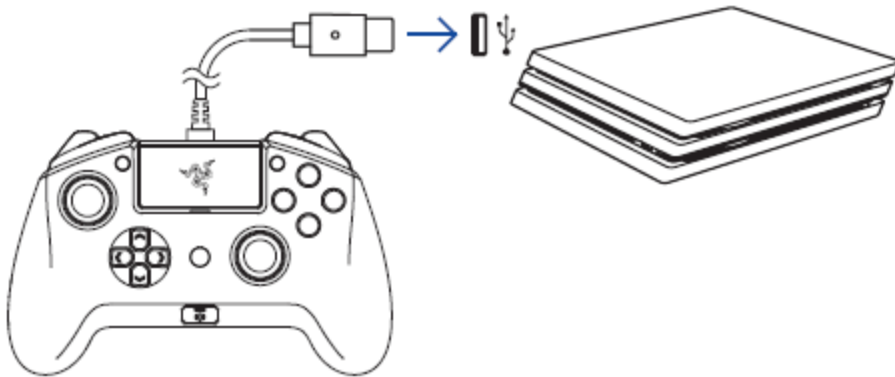

4. Press the PS button and your Razer Raiju Tournament Edition is ready to go.



WIRELESS MODE

i Make sure your gaming console is turned on before proceeding. Before pairing on wireless mode, you will need another device to navigate the PS4 menu such as the following:

- PS4/PS3 controller
- Mobile device with a Sony PS4 app
- TV remote with HDMI-CEC enabled
- Keyboard and/or mouse

Should you require additional assistance, please visit support.razer.com/contact-support

1. Set the Mode switch to **PS4 BT**.



2. Activate pairing mode by holding both the **SHARE** and **PS** buttons until the status indicator starts blinking rapidly.

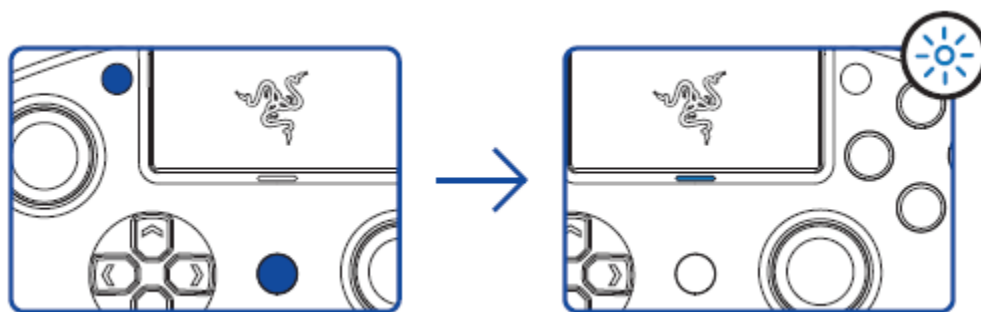

3. On your PS4, go to Settings > Devices > Bluetooth Devices and select Razer Raiju Tournament Edition.

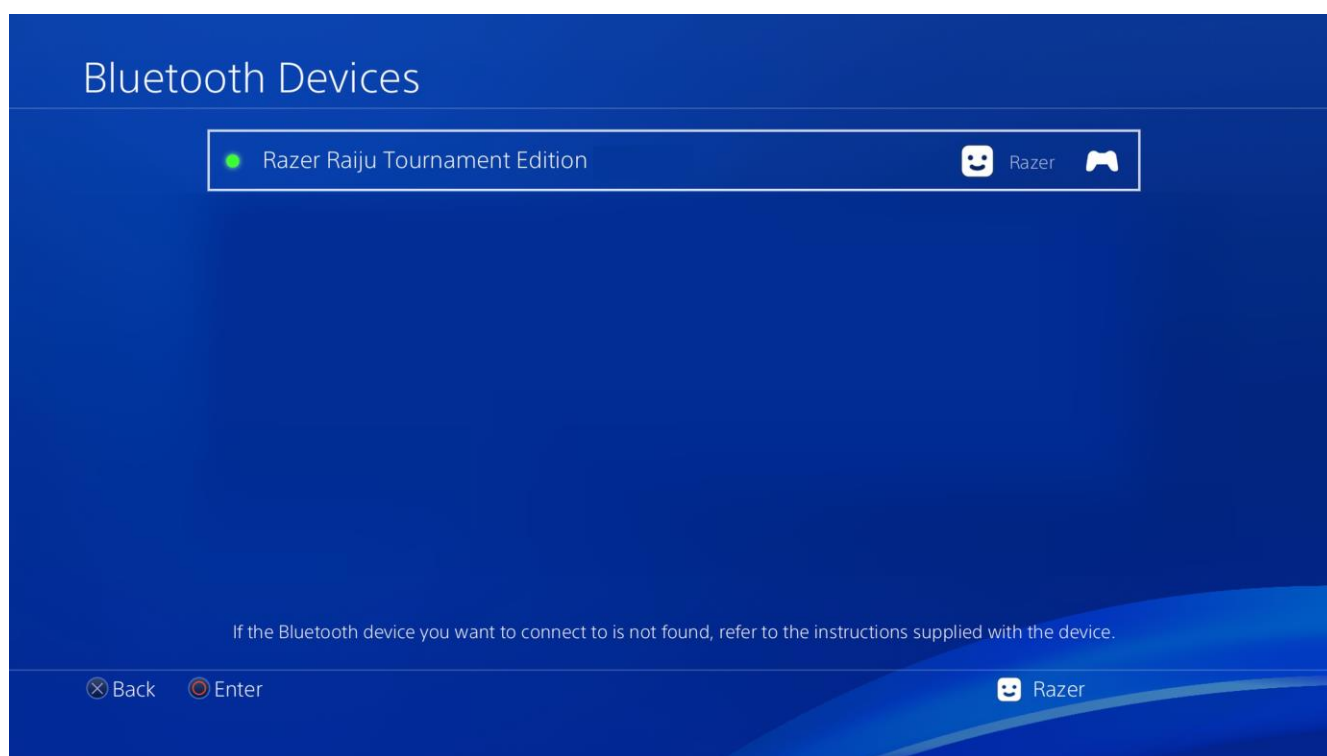

4. Choose **Yes** when asked to register the Bluetooth device.

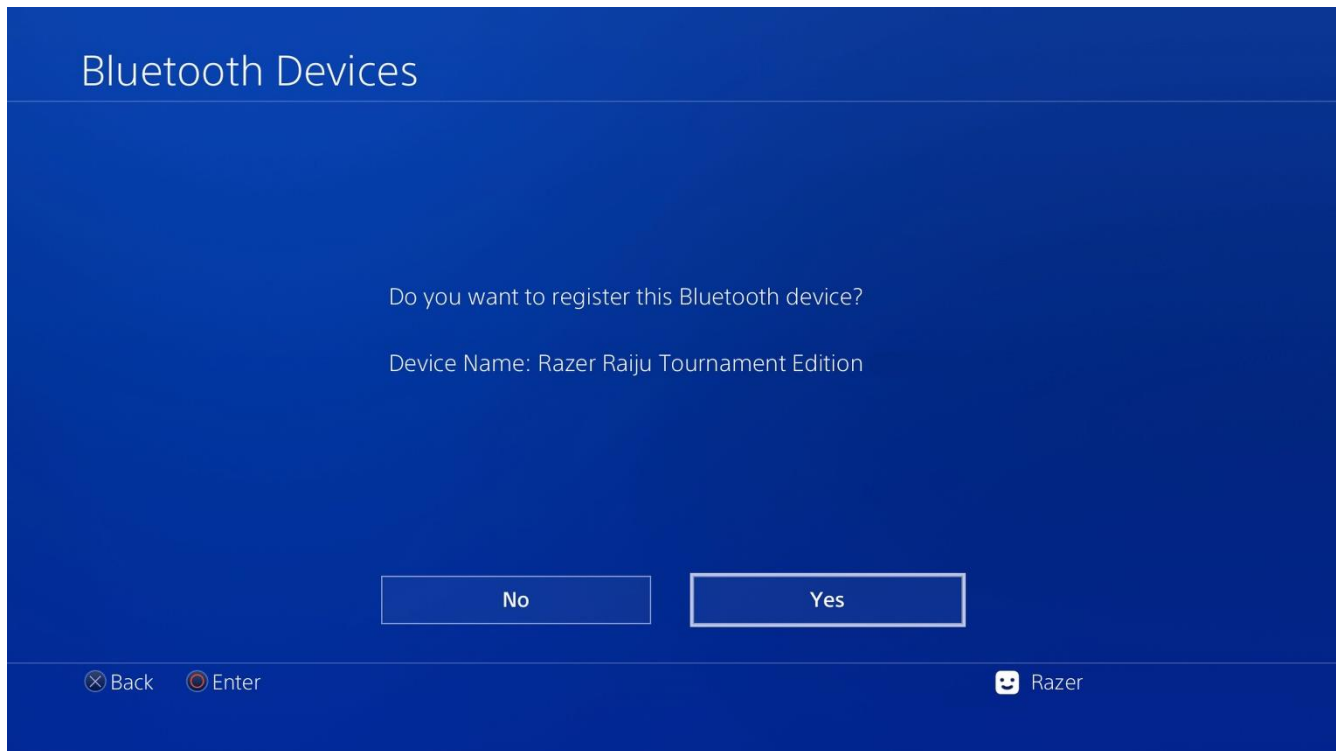

5. Wait until the status indicator stops blinking and your Razer Raiju Tournament Edition is ready to go.

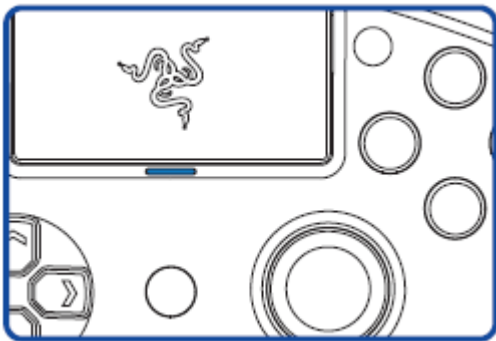

- i** *Pairing mode can be cancelled by holding the PS button until the controller turns off. Pairing mode will automatically stop if it does not pair with a device after 60 seconds.*

CONNECTING TO YOUR PC

WIRED MODE

1. Set the Mode switch to **USB**.



2. Plug the micro USB connector to your Razer Raiju Tournament Edition.

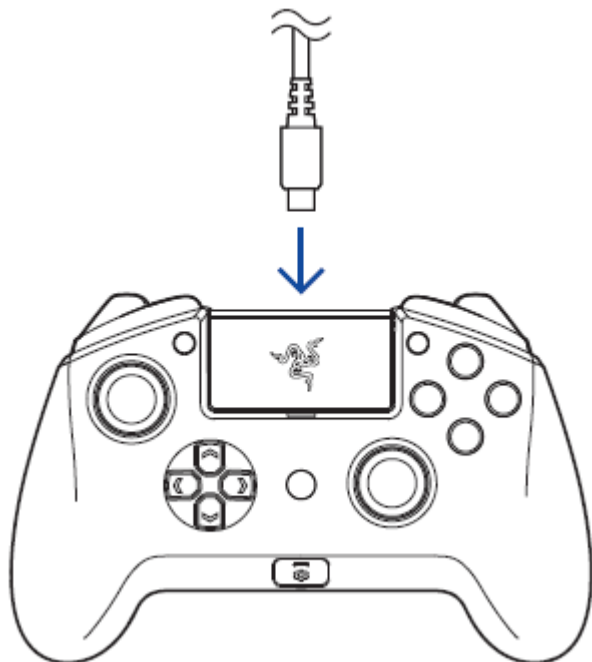

3. Connect your Razer Raiju Tournament Edition to your PC.

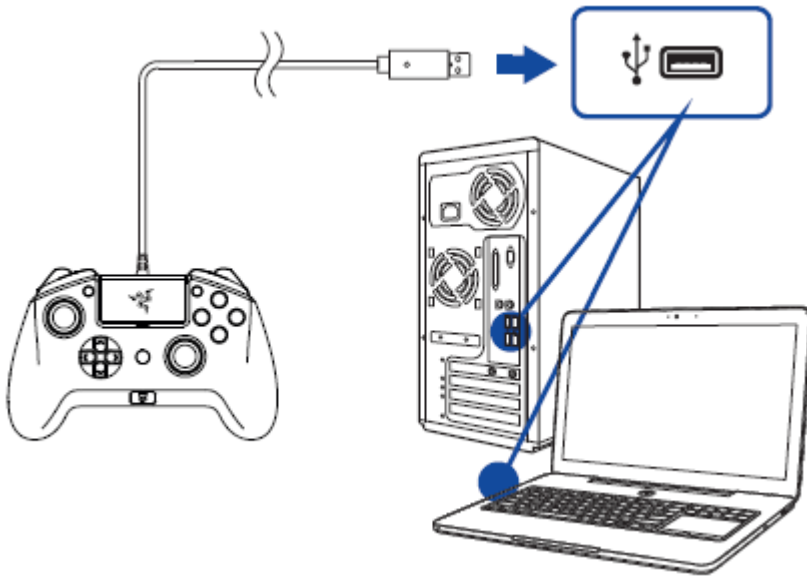

4. Wait until the drivers are automatically installed or manually update the drivers through the Device Manager.



WIRELESS MODE

i *Make sure your PC is turned on and Bluetooth connectivity is activated before proceeding.*

1. Set the Mode switch to **PC BT**.



2. Activate pairing mode by holding both the **OPTIONS** and **PS** buttons until the status indicator starts blinking rapidly.

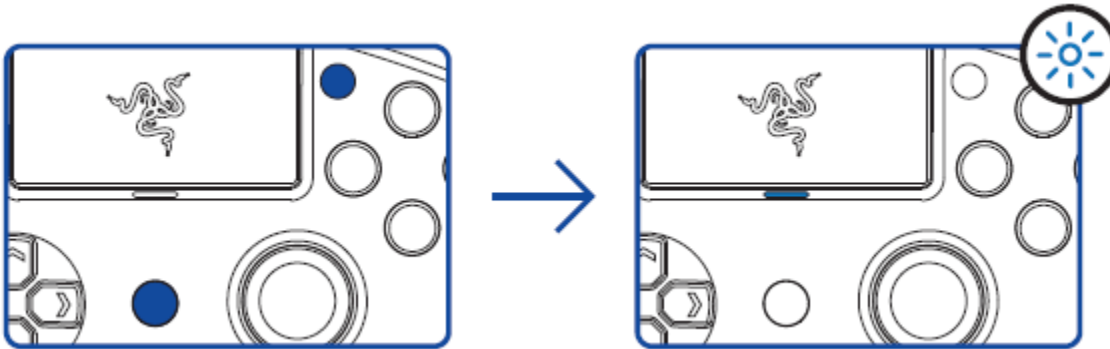

3. On your PC, go to **Settings > Devices > Bluetooth & other devices > Add Bluetooth or other device > Bluetooth** and select **Razer Raiju Tournament Edition**.

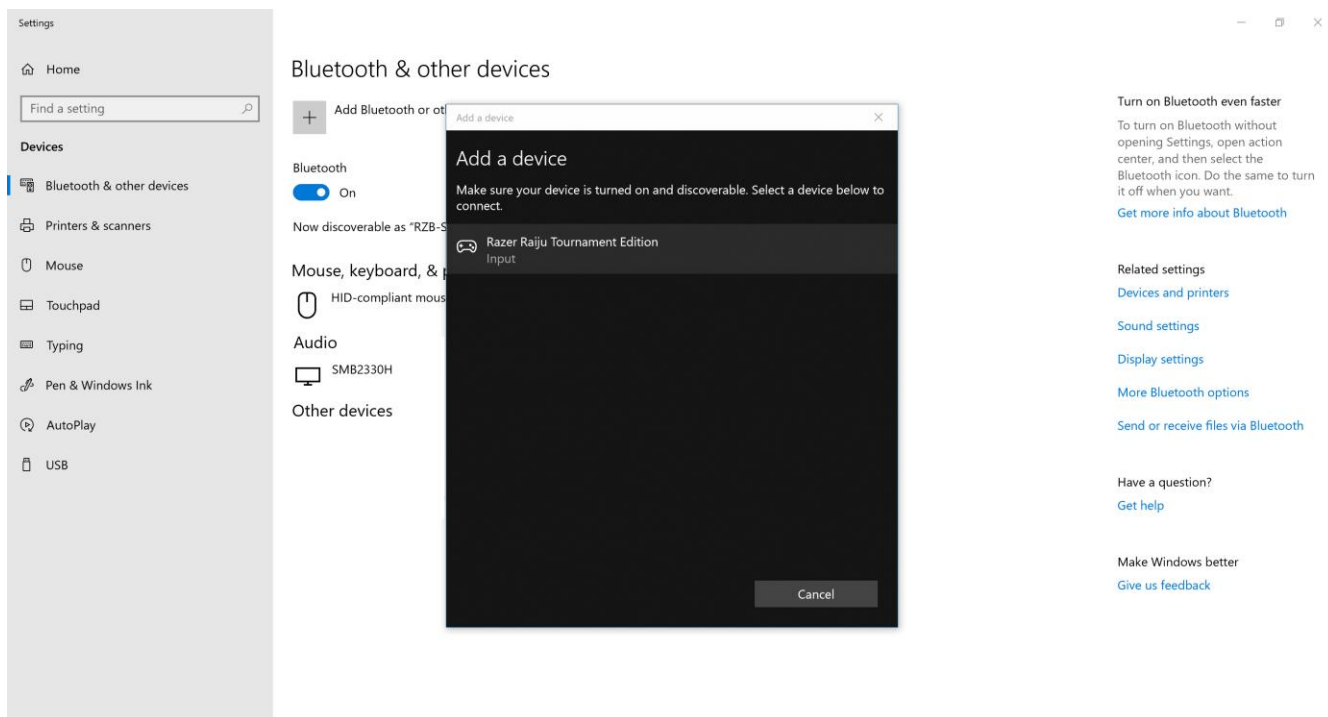

4. Click **Done** to close the confirmation screen and your Razer Raiju Tournament Edition is ready to go.

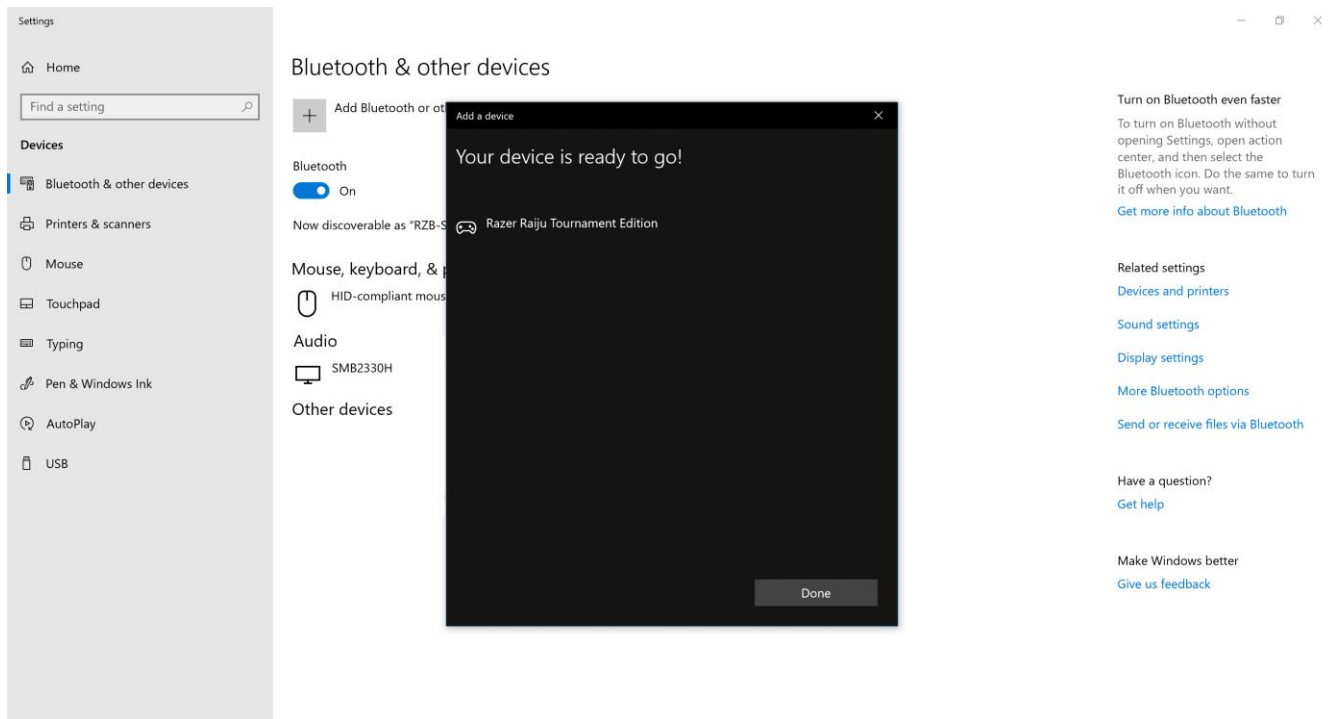

Pairing mode can be cancelled by holding the PS button until the controller turns off. Pairing mode will automatically stop if it does not pair with a device after 60 seconds.

If you need help with PC drivers or game platform compatibility, visit the FAQs [here](#).

6. USING YOUR RAZER RAIJU TOURNAMENT EDITION

USING THE TRIGGER STOP SWITCHES

The Trigger Stops allows you to activate the Left and Right Triggers faster by shortening their travel distance and reducing their response time (Active Hair Trigger Mode). To enable the Trigger Stops, simply slide the switches outwards; and to disable the Trigger Stops, slide the switches inwards.

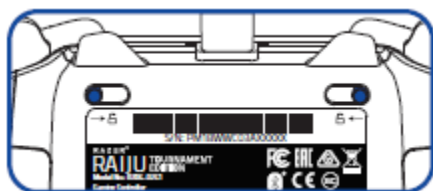

Enabled

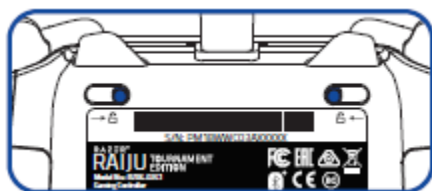

Disabled

USING THE CONFIGURE BUTTON

The Razer Raiju Tournament Edition has a configure button which you can use to connect / disconnect with the mobile app.

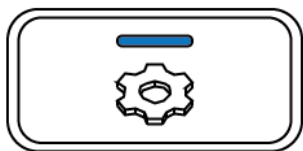

Connected

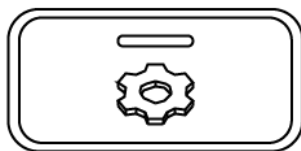

Disconnected

When connected to the mobile app, you can change your controller's button mappings, vibration levels, and analog stick sensitivity clutch levels.

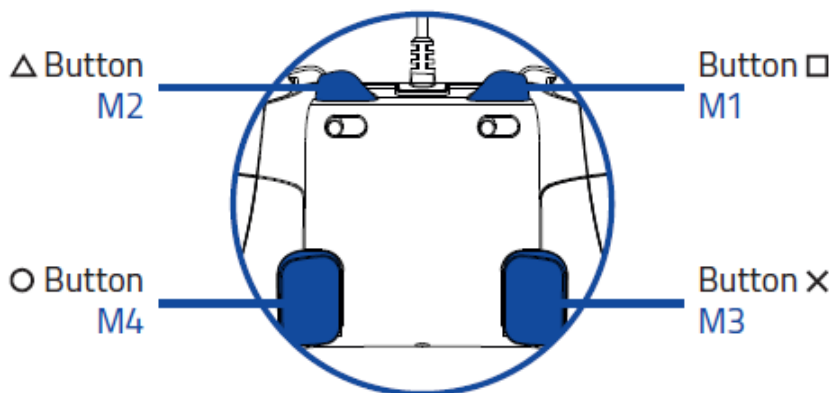

Default Multi-Function Buttons configuration

USING THE SENSITIVITY CLUTCH

The sensitivity clutch allows you to decrease the sensitivity of the analog sticks while the assigned button is held, to provide better aiming and handling. To use the sensitivity clutch, you will need to assign it to one of the Multi-Function Button using the mobile app.

CONFIGURING YOUR RAZER RAIJU TOURNAMENT EDITION

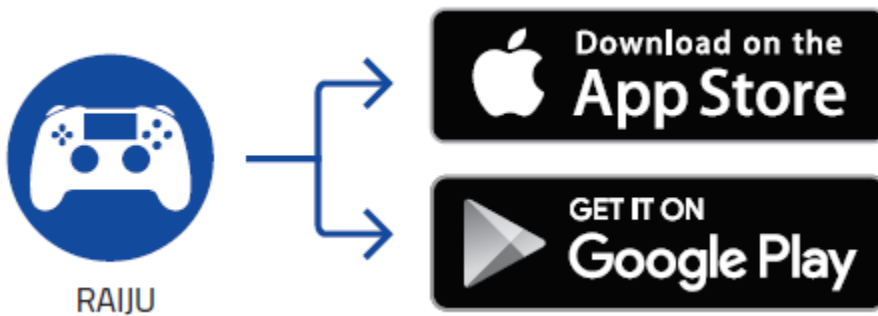

1. Download the mobile app on your mobile device.
2. Launch the app and follow the onscreen instructions.

7. USING THE RAZER RAIJU MOBILE APP

The Razer Raiju mobile app is an advanced configuration software that allows you to easily fine-tune your controller.

1. Once you have downloaded and launched the app*, you will need to add your controller. Select the controller you want to pair and follow the pairing instructions.

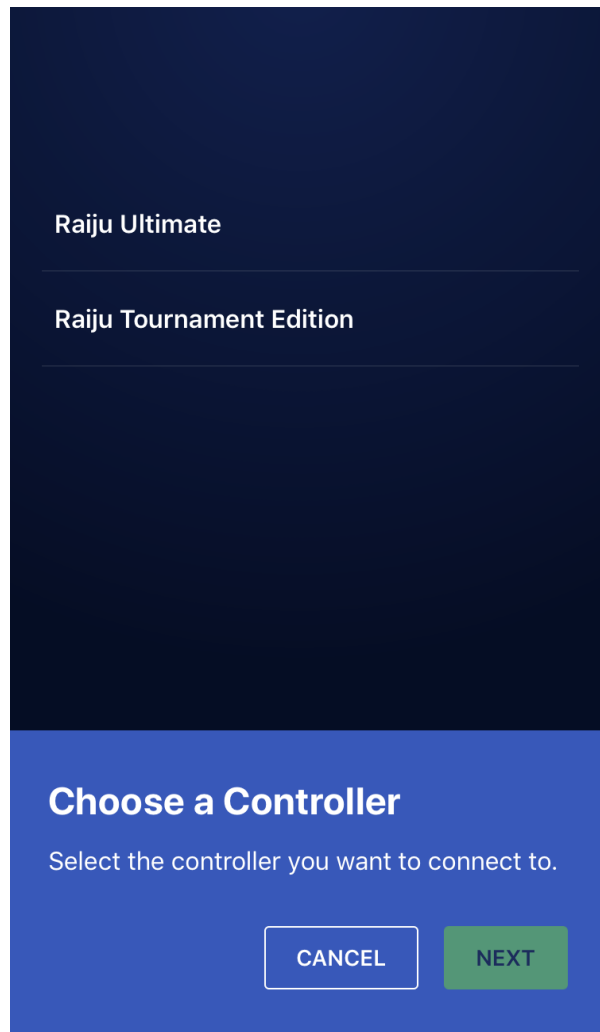
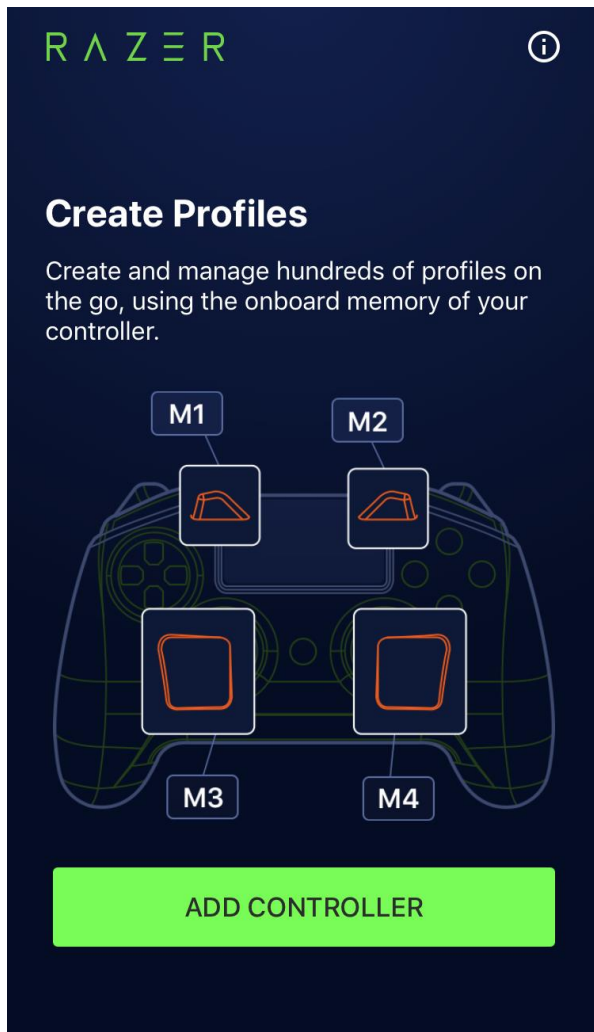

Note: For Android devices, you will need to enable Location services to use this app.

2. Once paired, you will have access to the main menu where you can create, edit, and store profiles. You can also switch controllers or reset all profiles to default using the dropdown option (▼).

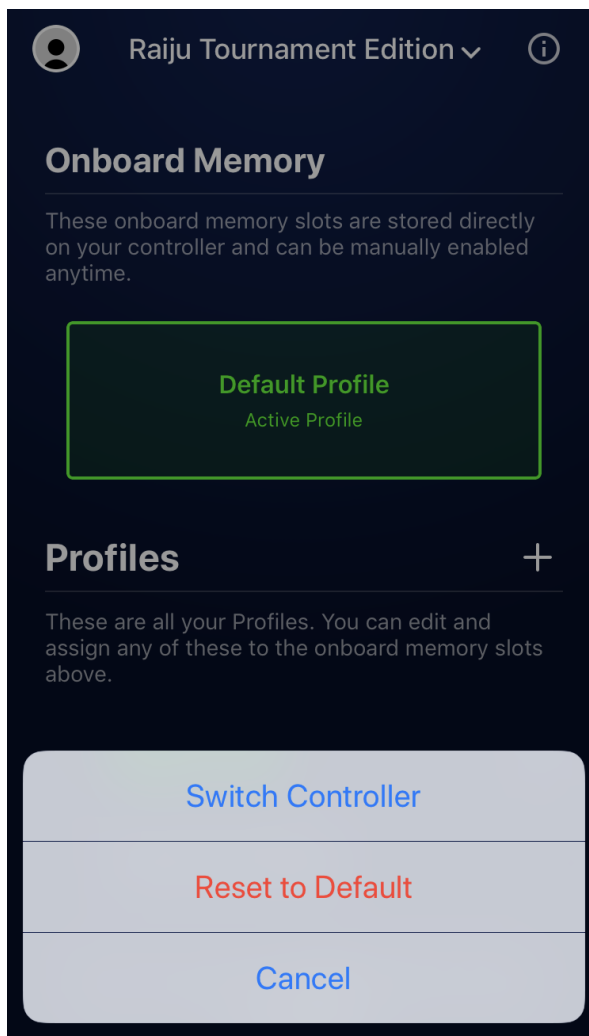
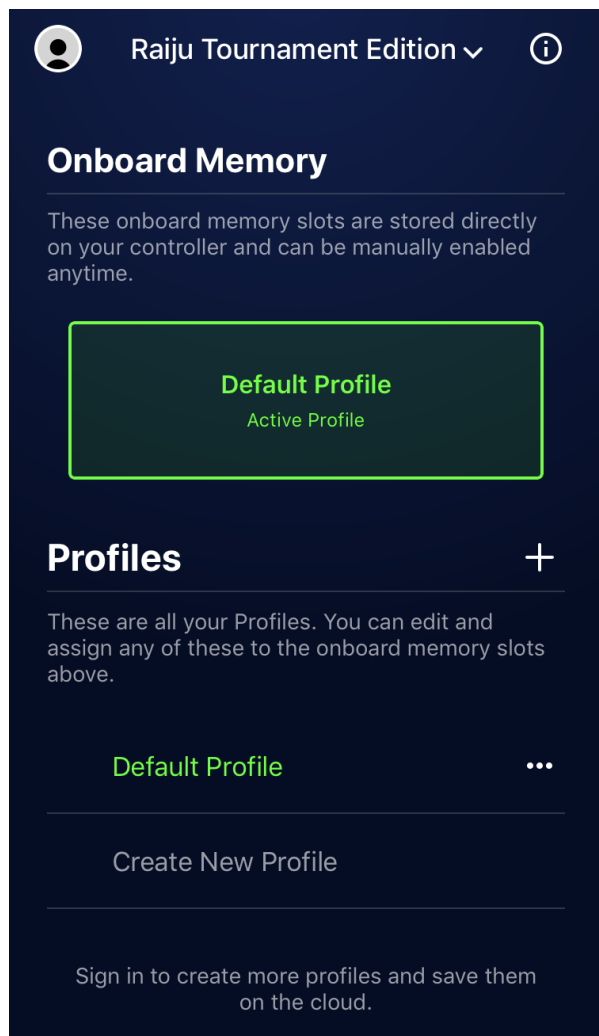

3. Sign in using your Razer ID or sign up for an account, by tapping the account icon (👤). From here, you can change your account settings, check the paired controller's status, send feedback, visit the FAQ list, view the Razer legalese, send log files to Razer Support, and sign out of your Razer ID. Once you have signed in, return to the main menu by tapping the close icon (✕).

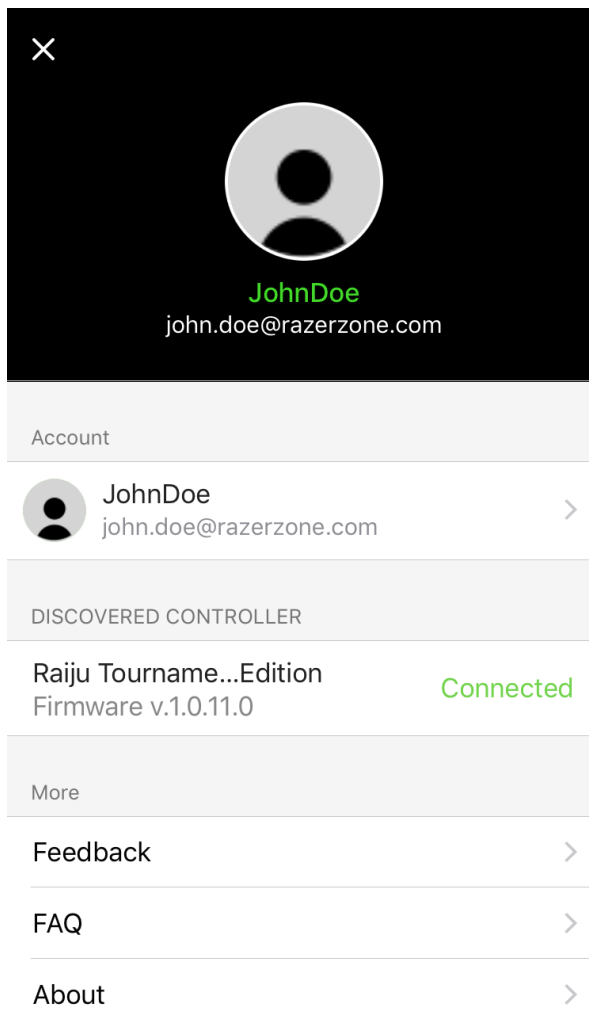
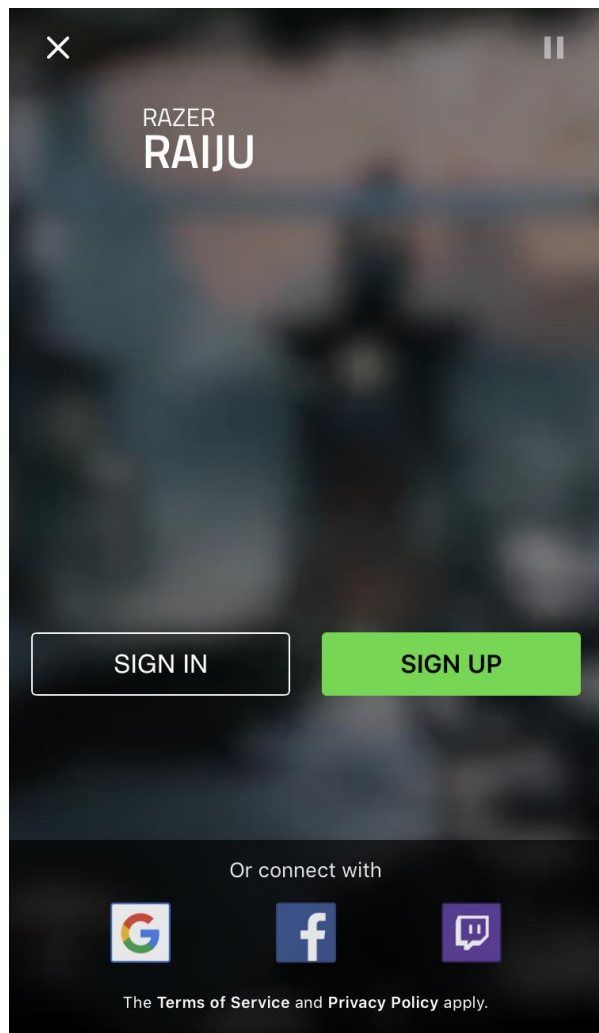

4. To activate an onboard profile, simply select it from the onboard memory list. Selecting the miscellaneous icon (•••) allows you to rename or copy an existing profile.

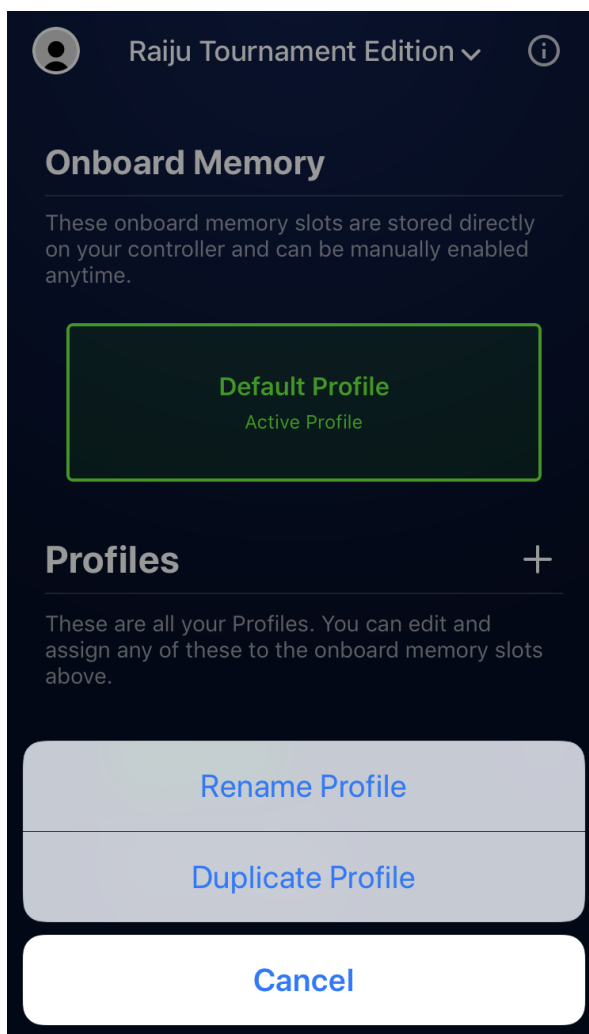
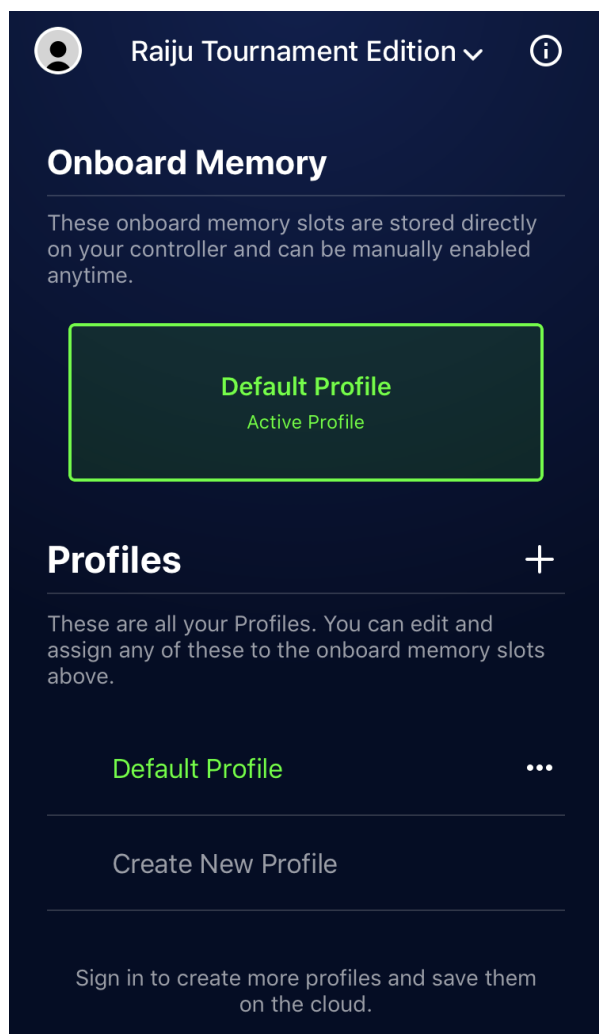

- To create a custom profile, you will need to sign in using your Razer ID account* then select the add icon (+) or select an open slot from the bottom of the profiles list. Selecting the miscellaneous icon (•••) enables you to activate, rename, copy, or delete the custom profile.

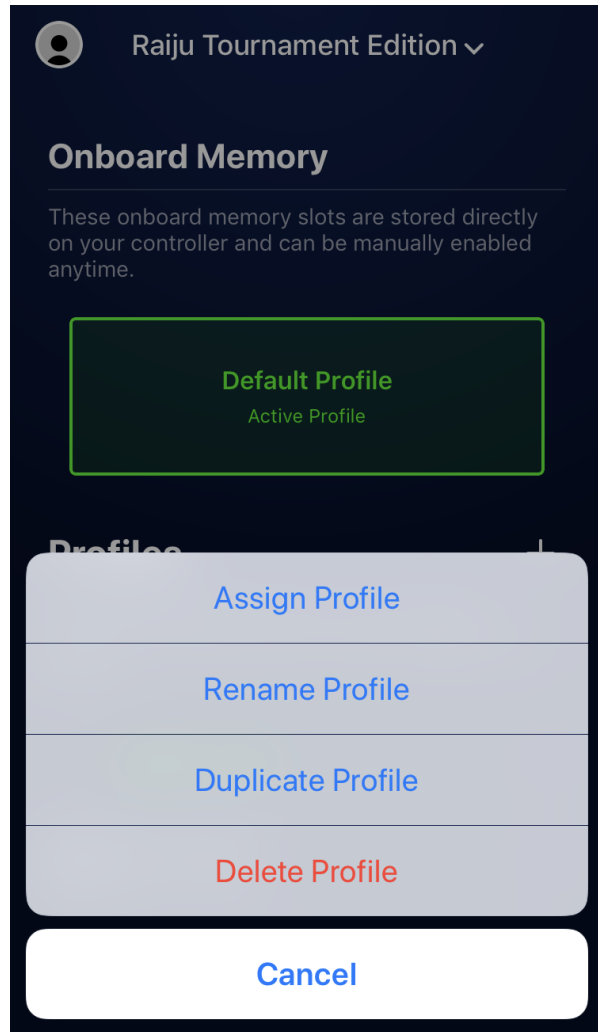
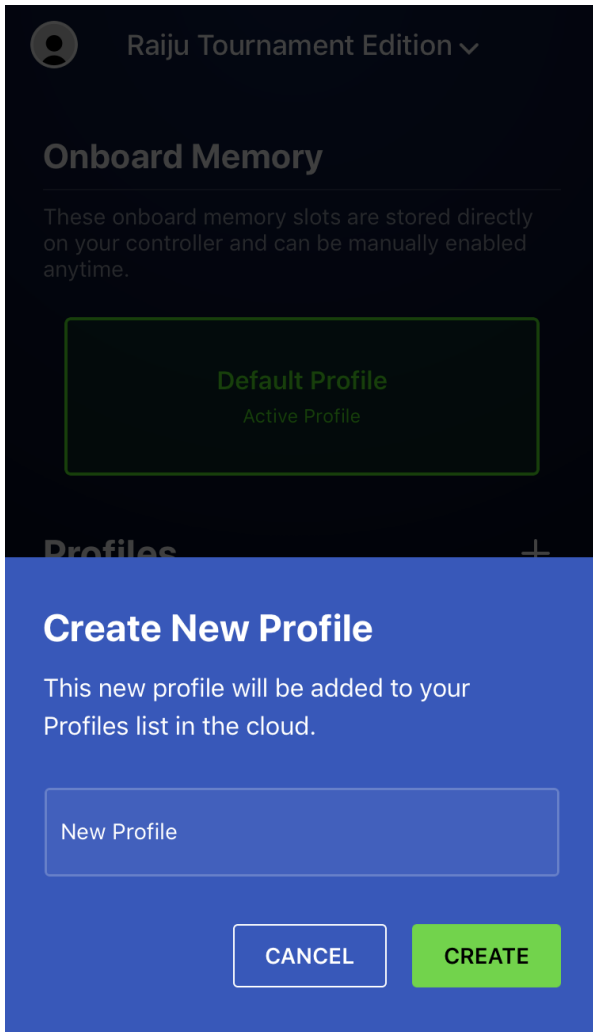

Note: To learn how to sign in or sign up for a Razer ID account, [click here](#).

- To edit your controller's settings, tap any profile from the list. From the Key Mapping section, you can remap any of the Multi-Function Buttons to a PlayStation controller button or a Sensitivity Clutch.

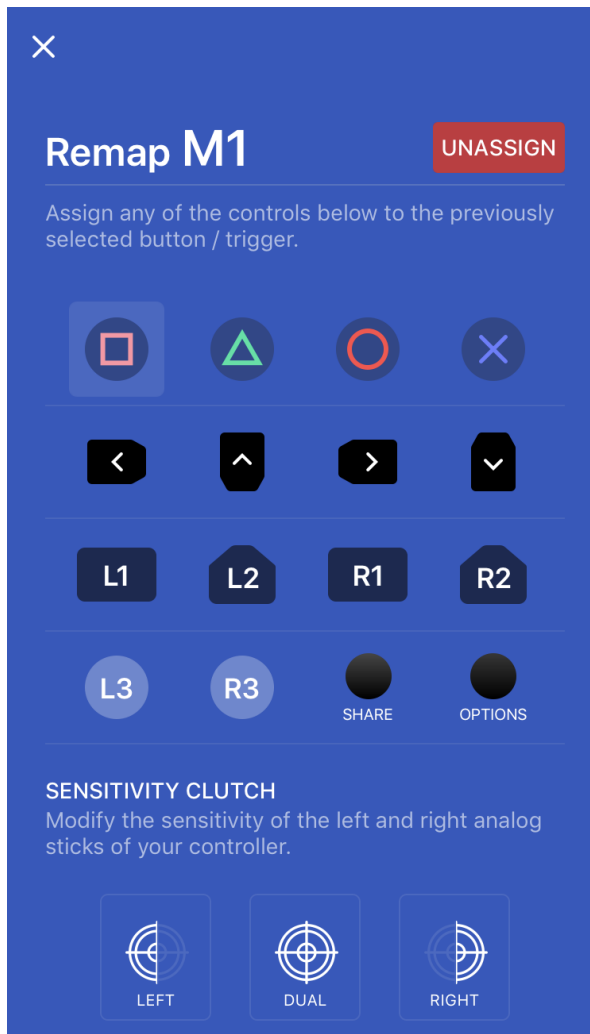
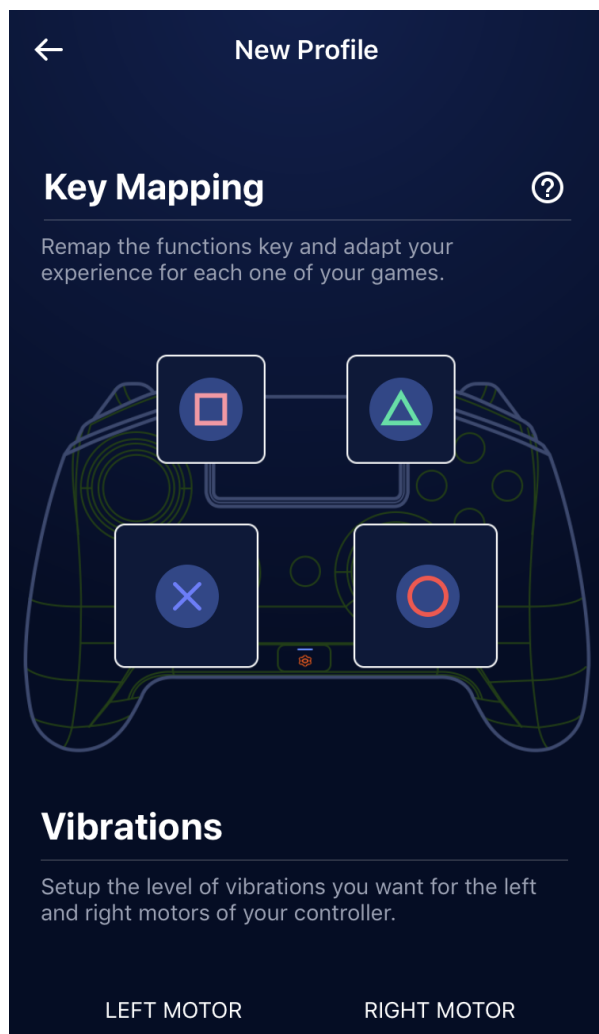

If you have assigned an MFB to Sensitivity Clutch, further options will become available. By default, the Sensitivity Clutch is set to the middle of the slider which reduces the movement speed of your analog stick/s by half. To further reduce the sensitivity, move the slider to the left or move the slider to the right to increase it. To use the sensitivity clutch, keep the assigned MFB pressed while you move the analog stick/s.



7. The Vibrations section allows you to set the intensity of each motor on the controller.

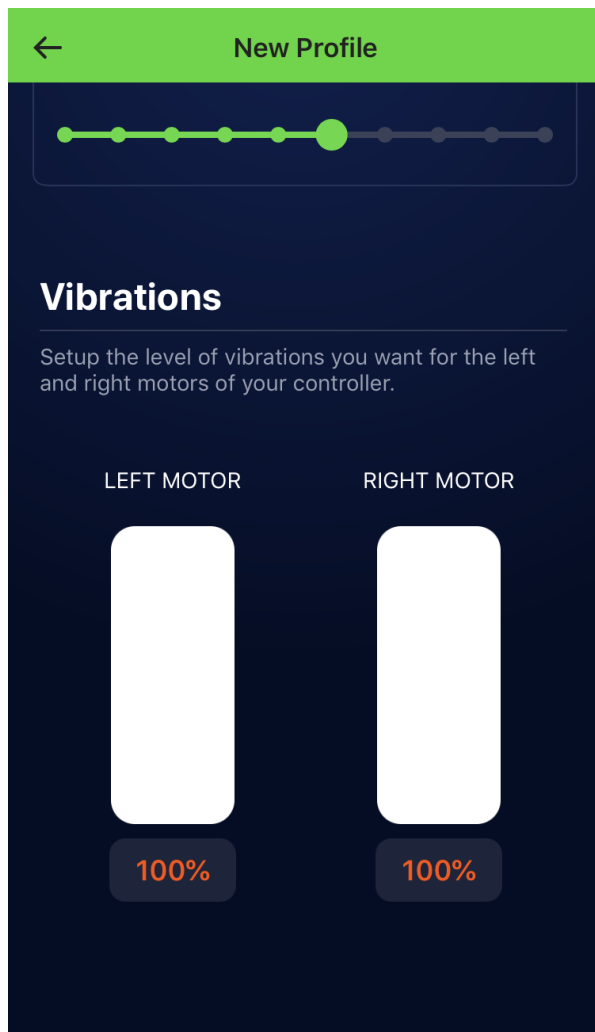

8. SAFETY AND MAINTENANCE

SAFETY GUIDELINES

In order to achieve maximum safety while using your Razer Raiju Tournament Edition, we suggest that you adopt the following guidelines:

Should you have trouble operating the device properly and troubleshooting does not work, unplug the device and contact the Razer hotline or go to support.razer.com for support.

Do not take apart the device (doing so will void your warranty) and do not attempt to operate it under abnormal current loads.

Keep the device away from liquid, humidity or moisture. Operate the device only within the specific temperature range of 0°C (32°F) to 40°C (104°F). Should the temperature exceed this range, unplug and/or switch off the device in order to let the temperature stabilize to an optimal level.

MAINTENANCE AND USE

The Razer Raiju Tournament Edition requires minimum maintenance to keep it in optimum condition. Once a month we recommend you unplug the device from the computer or console and clean it using a soft cloth or cotton swab to prevent dirt buildup. Do not use soap or harsh cleaning agents.

Do not clean the Razer Raiju Tournament Edition with alcohol-based solutions or other solvents. Doing so may tarnish the exterior surface of the controller.

9. LEGALESE

COPYRIGHT AND INTELLECTUAL PROPERTY INFORMATION

©2018 Razer Inc. All rights reserved. Razer, the triple-headed snake logo, Razer logo, "For Gamers. By Gamers.", and "Powered by Razer Chroma" logo are trademarks or registered trademarks of Razer Inc. and/or affiliated companies in the United States or other countries. All other trademarks and trade names are the property of their respective owners and other company and product names mentioned herein may be trademarks of their respective companies.

iOS is a trademark or registered trademark of Cisco in the U.S. and other countries and is used under license. App Store is a service mark of Apple Inc.

Android™ and Google Play™ are trademarks of Google Inc.

The Bluetooth® word mark and logos are registered trademarks owned by Bluetooth SIG, Inc., and any use of such marks by Razer is under license.

", "PlayStation", "ΔOX□", "PS3" and "PS4" are registered trademarks of Sony Interactive Entertainment Inc. All rights reserved.

Razer Inc. ("Razer") may have copyright, trademarks, trade secrets, patents, patent applications, or other intellectual property rights (whether registered or unregistered) concerning the product in this guide. Furnishing of this guide does not give you a license to any such copyright, trademark, patent or other intellectual property right. The Razer Raiju Tournament Edition (the "Product") may differ from pictures whether on packaging or otherwise. Razer assumes no responsibility for such differences or for any errors that may appear. Information contained herein is subject to change without notice.

LIMITED PRODUCT WARRANTY

For the latest and current terms of the Limited Product Warranty, please visit [razer.com/warranty](https://www.razer.com/warranty).

LIMITATION OF LIABILITY

Razer shall in no event be liable for any lost profits, loss of information or data, special, incidental, indirect, punitive or consequential or incidental damages, arising in any way out of distribution of, sale of, resale of, use of, or inability to use the Product. In no event shall Razer's liability exceed the retail purchase price of the Product.

GENERAL

These terms shall be governed by and construed under the laws of the jurisdiction in which the Product was purchased. If any term herein is held to be invalid or unenforceable, then such term (in so far as it is invalid or unenforceable) shall be given no effect and deemed to be excluded without invalidating any of the remaining terms. Razer reserves the right to amend any term at any time without notice.